

The base-plate pole sits on a square steel baseplate and is supported by 4 vertical gussets. The pole usually starts at a larger diameter than the top part. All poles are listed by their top diameter as that is what is important when mounting one of our solar structures. All base-plate poles are hot-dipped galvanized. Base-plate poles require a subterranean bolt cage to be pre-constructed on which to bolt the pole onto.

Details

PoleLength	4,00
PoleSize	90

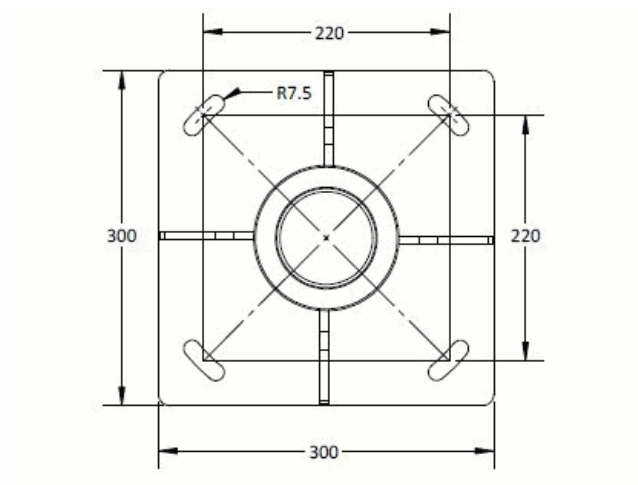
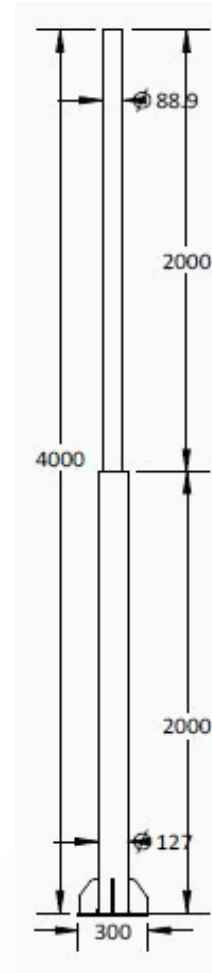

Installation Options

Standard Pole

Stepped Pole

Base-Plate Pole

Wall Pole

